



brought to you by:

STORAGE SYSTEMS



**Storage Systems Ltd.,
Malahide Road Industrial Park,
Malahide Road,
Coolock,
Dublin 17,
Ireland**

**Tel: + 353 1 847 0956
Fax: + 353 1 847 9892
email: sales@storagesystems.ie**

Workbenches dimensions

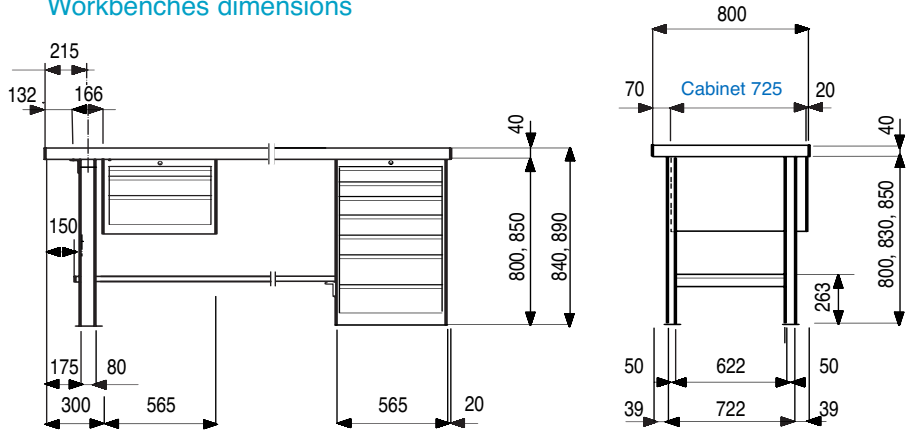

Locating distances of the workbench tops

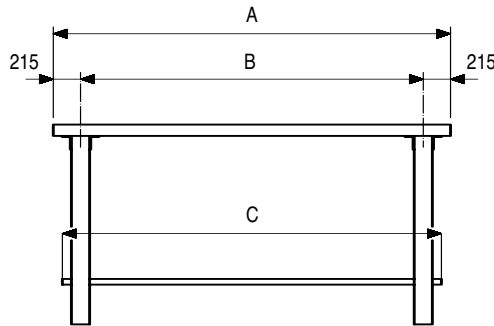

A	B	C
mm	mm	mm
1500	1070	1200
1750	1320	1450
2000	1570	1700

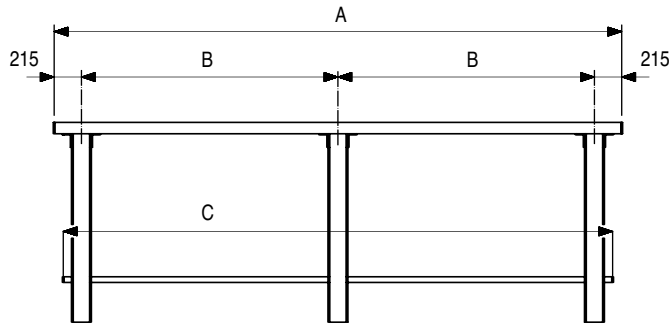

A	B	C
mm	mm	mm
2500	1035	2200
3000	1285	2700

Wooden tops, 40 mm thick

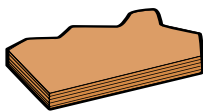

Length	Depth without rear panel	Rear panel height	Code
mm	mm	mm	
1500	800	-	751.91.35.0
		50	752.91.35.0
1750	800	-	756.91.35.0
		50	757.91.35.0
2000	800	-	761.91.35.0
		50	762.91.35.0
2500*	800	-	766.91.35.0
		50	767.91.35.0
3000 *	800	-	771.91.35.0
		50	772.91.35.0

*3 supports points are necessary

Bench legs

Steel sheet construction, powder-coated according to the colour chart. Upper support with 6 holes for fastening of wooden top. Drilled base plates for floor anchoring.

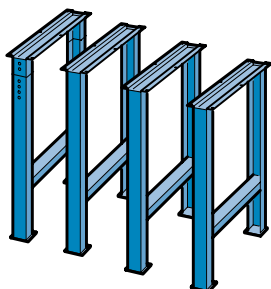

Width	Depth	Height	For bench height	Code
mm	mm	mm	mm	
80	722	800	840	658.00.00.0
80	722	830	870	659.00.00.0
80	722	850	890	660.00.00.0
80	722	750 - 1050 *	790 - 1090	663.00.00.0

Fastening material, without pre-assembly

662.00.00.0

*Adjustable every 25 mm

Support consoles

Steel sheet construction, powder-coated according to the colour chart.
Housing with side door and safety cylinder lock. Upper part for pneumatic connections, lower part with two C-profiles for installation of instruments, transformers, etc.. Front part for socket panels or dummy covers.
Side holes allow the introduction of cables and air pipes. Console can be mounted either to the right or left side of the bench.

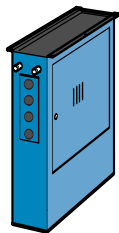

Width	Depth	Height	Door position	Code
mm	mm	mm		
190	675	700	right	669.90.00.0
190	675	700	left	669.91.00.0
190	675	800	right	669.92.00.0
190	675	800	left	669.93.00.0
190	675	830	right	669.94.00.0
190	675	830	left	669.95.00.0
190	675	850	right	669.96.00.0
190	675	850	left	669.97.00.0

Fastening material, without pre-assembly 662.00.00.0

Socket covers

Steel sheet construction, powder-coated according to the colour chart. Supplied with four fixing screws.

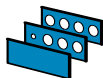

For 4 socket	Code
	670.90.00.0
For 3 and 1 test terminal	Code
	670.91.00.0
Cover without holes, for installation by the customer	Code
	670.92.00.0

Adjustable shelves

Plywood shelf, 25 mm thick, planed and impregnated.

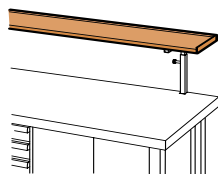

Width	Depth	No. of brackets	Code
mm	mm		
1500	300	2	673.90.00.0
1750	300	2	673.91.00.0
2000	300	2	673.92.00.0
2500	300	3	673.93.00.0
3000	300	3	673.94.00.0

Maximum distance between the brackets 1600 mm

Adjustable shelf brackets

Tubular steel, powder-coated according to the colour chart.
Height adjustable. To be bolted to the workbench top. Fastening material included.

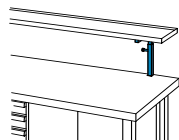

Depth	Height over bench top	Code
mm	mm	
280	230 - 350	672.00.00.0

Riser shelf, between bench legs

Multiplex shelf, 25 mm thick.

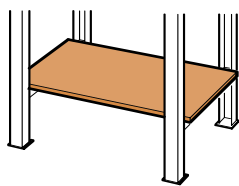

For bench length	Shelf length	Shelf depth	Code
mm	mm	mm	
1500	1200	620	676.90.00.0
1750	1450	620	676.91.00.0
2000	1700	620	676.92.00.0
2500	2200	620	676.93.00.0
3000	2700	620	676.94.00.0

Riser shelf, between drawer cabinet and bench legs

Multiplex shelf, 25 mm thick
Steel sheet angle support, powder-coated according to the colour chart. Fastening material included.

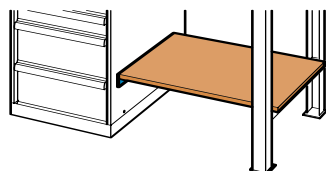

For bench length	Shelf length	Shelf depth	Code
mm	mm	mm	
1500	765	620	677.91.00.0
1750	1015	620	677.92.00.0
2000	1265	620	677.93.00.0
2500	1765	620	677.94.00.0
3000	2265	620	677.95.00.0

Angle support 679.00.00.0
Other executions on request

Foot rest

Steel sheet construction, powder-coated according to the colour chart.

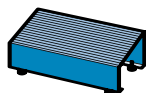

Width	Depth	Height	Code
mm	mm	mm	
500	250	140	678.90.00.0

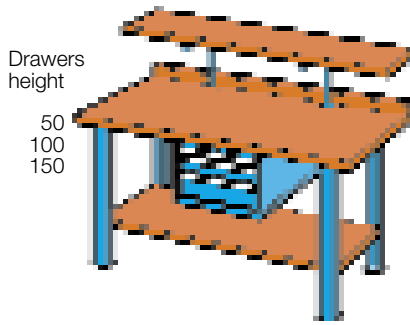

Drawers height
50
100
150

Length
1500 mm
2000 mm

Code
751.00.00.3
761.00.00.8

2 bench legs
1 cabinet
1 riser shelf
2 adjustable shelf brackets / 1 adjustable shelf

Height 870 mm Depth 800 mm

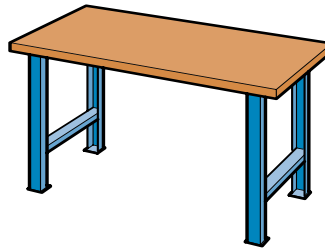

Length
1500 mm
1750 mm
2000 mm

Code
751.00.00.1
756.00.00.1
761.00.00.1

1 bench legs

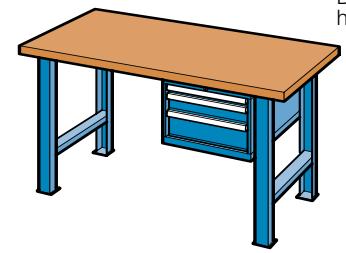

Drawers height
50
100
150

Length
1500 mm
1750 mm
2000 mm

Code
751.00.00.2
756.00.00.2
761.00.00.2

2 bench legs
1 cabinet

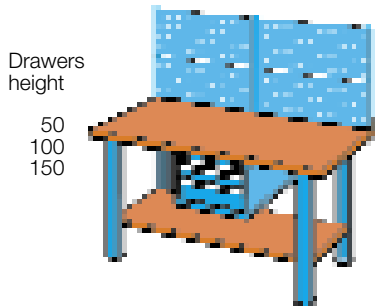

Drawers height
50
100
150

Length
1500 mm
2000 mm

Code
751.00.00.4
761.00.00.9

2 bench legs
1 cabinet
1 riser shelf
3 panel brackets / 4 perforated panels 9 mm square holes with 38 mm centre to centre distance

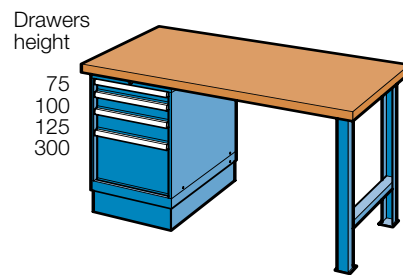

Drawers height
75
100
125
300

Length
1750 mm
2000 mm

Code
756.00.00.3
761.00.00.3

2 bench legs
1 cabinet with base H=130 mm

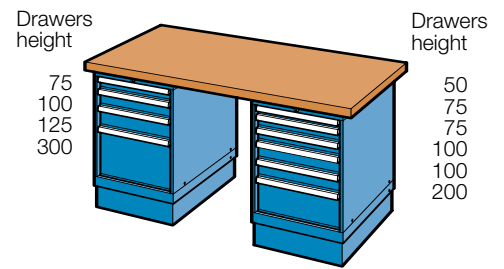

Drawers height
75
100
125
300

Drawers height
50
75
75
100
100
200

Length
1750 mm
2000 mm

Code
756.00.00.4
761.00.00.4

2 cabinets with bases H=130 mm

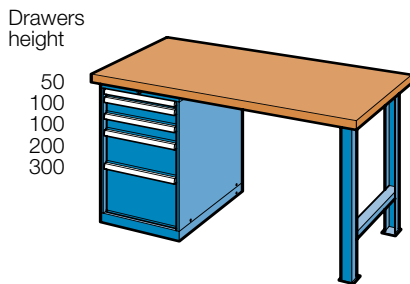

Drawers height
50
100
100
200
300

Length
1750 mm
2000 mm

Code
756.00.00.5
761.00.00.5

2 bench legs
1 cabinet

Height 890 mm Depth 800 mm

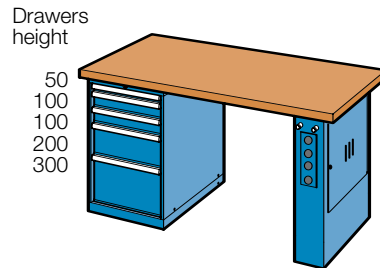

Drawers height
50
100
100
200
300

Length
1750 mm
2000 mm

Code
756.00.00.6
761.00.00.6

1 support console
1 cabinet

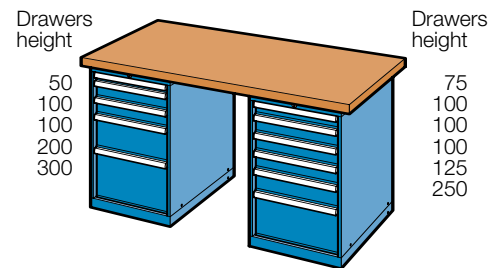

Drawers height
50
100
100
200
300

Drawers height
75
100
100
100
125
250

Length
1750 mm
2000 mm

Code
756.00.00.7
761.00.00.7

2 cabinets

Drawer for workbench type J 12
(Code 022.00.00.0)

Drawer height
150

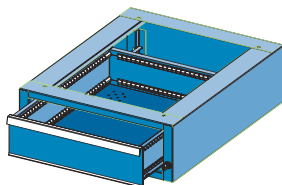

Height 250 mm Width 565 mm
Usable height 150 mm Depth 725 mm
Drawer dim. Depth 621 mm Width 459 mm

Steel sheet construction, powder-coated according to the colour chart. Useful to store all those tools habitually used on top of the workbench. Provided with one drawer of 150S and cylinder lock, it is fastened under the workbench wooden top by proper bolts.

Code
Drawer single extension 022.00.00.0

Housing Type B 210
(Code 022.24.22.0)

Height 400 mm
Usable height 300 mm
Width 565 mm
Depth 725 mm

Drawers height
50
100
150

3 Drawers

Code
022.00.22.1

Drawers height
50
50
50
150

4 Drawers

Code
022.00.22.2

Drawers height
100
200

2 Drawers

Code
022.00.22.3

Housing Type B 211
(Code 022.24.37.0)

Height 550 mm
Usable height 450 mm
Width 565 mm
Depth 725 mm

Drawers height
50
75
125
200

4 Drawers

Code
022.00.37.1

Drawers height
50
75
75
100
150

5 Drawers

Code
022.00.37.2

Drawers height
50
50
75
75
100
100

6 Drawers

Code
022.00.37.3

Housing Type B 212
(Code 022.24.25.0)

Height 700 mm
Usable height 600 mm
Width 565 mm
Depth 725 mm

Drawers height
75
100
125
300

4 Drawers

Code
022.00.25.1

Drawers height
75
75
100
150
200

5 Drawers

Code
022.00.25.2

Drawers height
75
75

2 Drawers

Pull-out shelf
Door 450 mm
Drawers and shelves
single extension
Code
022.00.25.3

Housing Type B 215
(Code 022.24.26.0)

Height 800 mm
Usable height 700 mm
Width 565 mm
Depth 725 mm

Drawers height
50
100
100
150
300

5 Drawers

Code
022.00.26.1

Drawers height
75
75
100
100
150
200

6 Drawers

Code
022.00.26.2

Drawers height
100
150

2 Drawers

Drawers and shelves
single extension
Code
022.00.26.3

Housing Type B 214
(Code 022.24.27.0)

Height 850 mm
Usable height 750 mm
Width 565 mm
Depth 725 mm

Drawers height
50
100
100
200
300

5 Drawers

Code
022.00.27.1

Drawers height
75
100
100
100
125
250

6 Drawers

Code
022.00.27.2

Drawers height
150

1 Drawers

Adjustable shelf
Pull-out shelf
Door 600 mm
Drawers and shelves
single extension
Code
022.00.27.3

Housing Type B 213
(Code 022.24.29.0)

Height 1000 mm
Usable height 900 mm
Width 565 mm
Depth 725 mm

Drawers height
75
75
100
150
200
300

6 Drawers

Code
022.00.29.1

Drawers height
50
75
75
75
125
150
200

8 Drawers

Code
022.00.29.2

Drawers height
50
100
150

3 Drawers

Adjustable shelf
Pull-out shelf
Door 600 mm
Drawers and shelves
single extension
Code
022.00.29.3